

Over 20 years of custom doors and windows

DALLAS

Millwork

EST. 1996



Custom Crafted
Interior & Exterior Doors
Custom Windows
Historic Renovations

IDEA BOOK



HOW DOES YOUR
DOOR
WELCOME YOU?

Welcome

The doors and windows
you are about to see are from
previous projects and orders.

Nothing is standard,
off the shelf, or
ready to assemble, just custom.

So dream big and let us make
your dreams come true!

MADE IN THE USA!

About Dallas Millwork.

“Our mission is to provide the best quality custom millwork in the industry.”

We strive for excellence through the use of cutting edge technology and state-of-the-art equipment, premium woods and materials, all operated by skilled craftsmen and women who share our common goals.

Dallas Millwork, Incorporated has been manufacturing quality custom millwork, since 1996, serving thousands of customers from around the globe.

We are located in Hiram, Georgia, under 70,000 square feet of manufacturing space, and employing over 50 craftsmen and women.



Since we employ a team of architectural design specialists, we gladly provide each customer with a CAD drawing of each window and door we produce. This ensures order accuracy and flexibility backed by a team of customer support representatives who have the experience and know-how to assist you before, during and after your order is fulfilled.

Simply put, Dallas Millwork works for you!





Our doors
and windows
are
100%
Custom
Designed
using the
highest
quality
materials
and
craftsmanship.



“ From concept to reality, Dallas Millwork can take your ideas and transform them into the custom doors and windows you’ve always dreamed of...

...just dream a little and let us make it happen!”

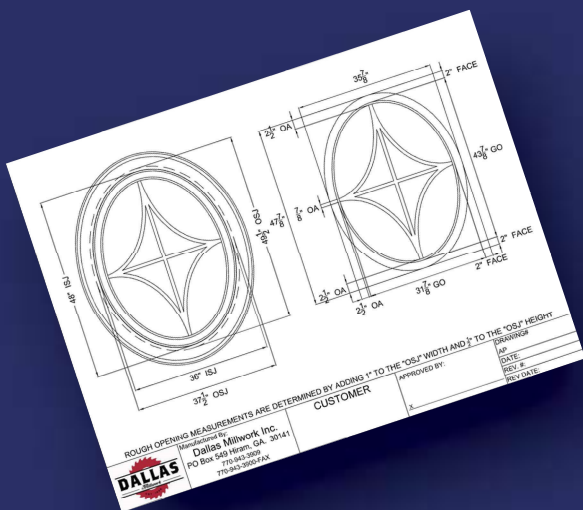



The Finest Wood Species

Sapele♥
Accoya*
Knotty Alder
Superior
Alder
Cherry
Cypress
Fir
Maple

Poplar
Red Oak
White Oak
Spanish
Cedar
Walnut

♥ Favorite

*Rot Resistant

Best Quality Materials

Glass Options: Available in Clear SSB, Clear Insulated, Energy Efficient Low-E, Beveled, Patterned glass types and custom leaded glass.

Grille Profiles: Available in Simulated Divided Lite (SDL) or True Divided Lite (TDL) profiles are available in several standard profiles. We can also create custom profiles for a personal look or to match existing conditions.

Trim Profiles: From Brickmould and S4S to your own design, we have several hundred options.

Hardware Options: Single Bore, Double Bore, Amesbury Tru-Lock, Hoppe Multi Point, or a custom mortise prep can all be done on the active door. Dallas Millwork utilizes a single throw head and foot bolt system on the passive door of double door units.

Sill Options: Aluminum Adjustable Sill, Wood Sill, Handicap Sill, or an interlocking threshold can all be utilized on our doors.

Custom Design Options

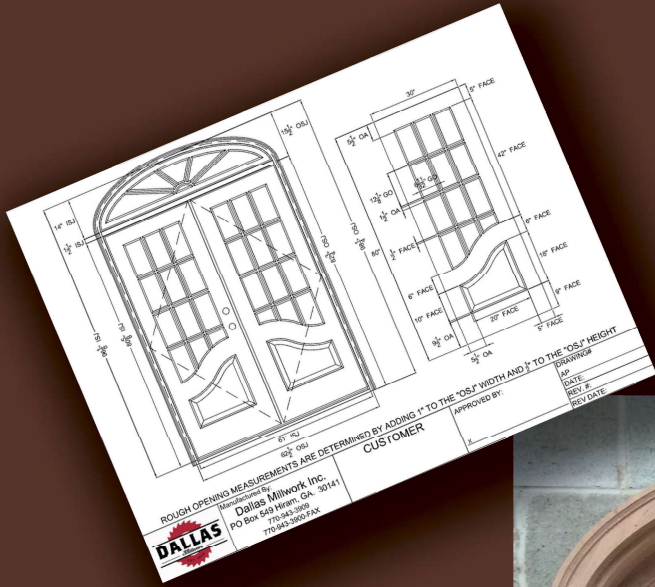

CAD Drawings
Included

Trim
Options

Grille
Options

Glass
Options

Hardware
Options

Sill
Options





Contractor's Showcase

Previous Custom Designs





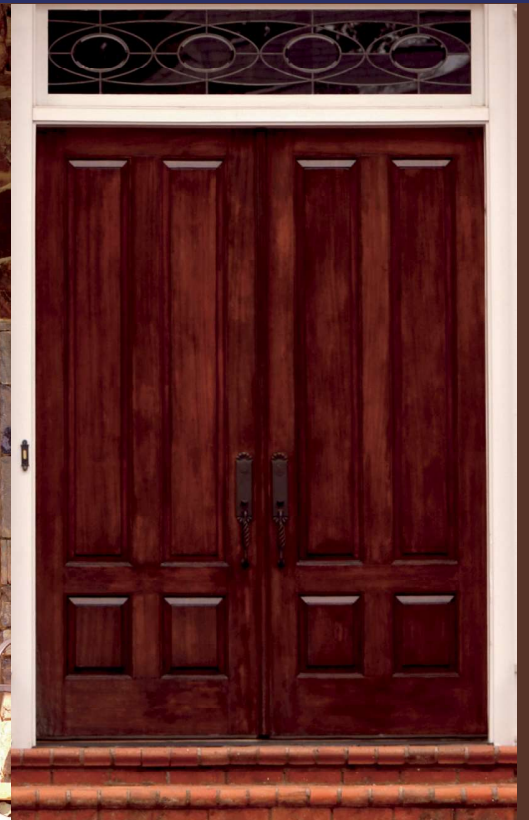
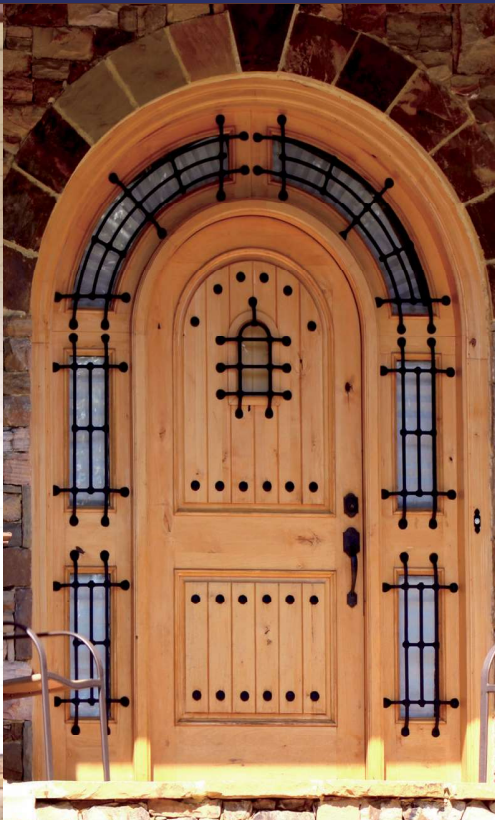

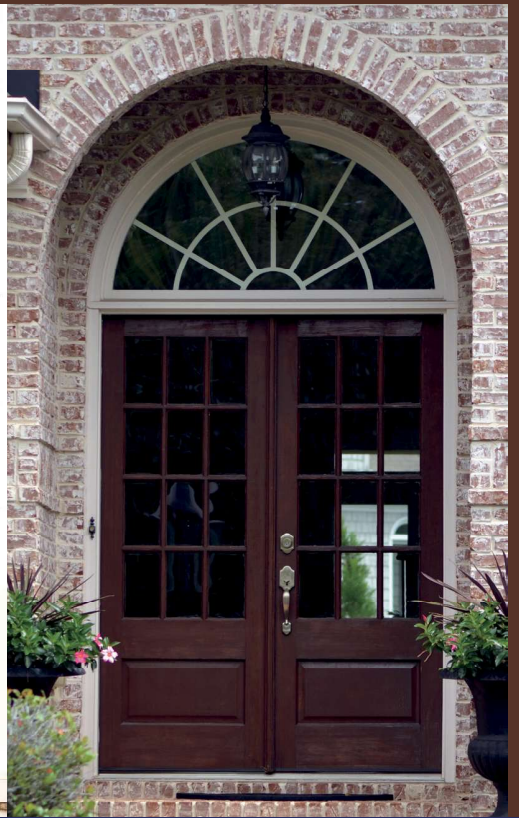
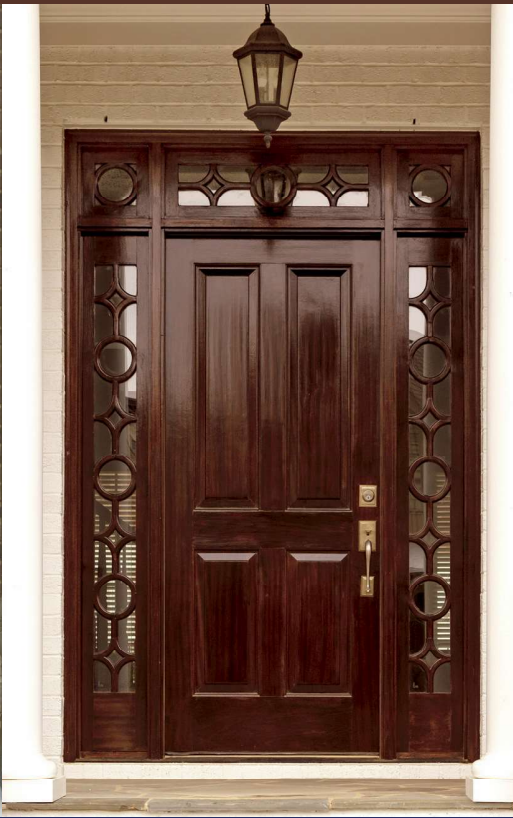

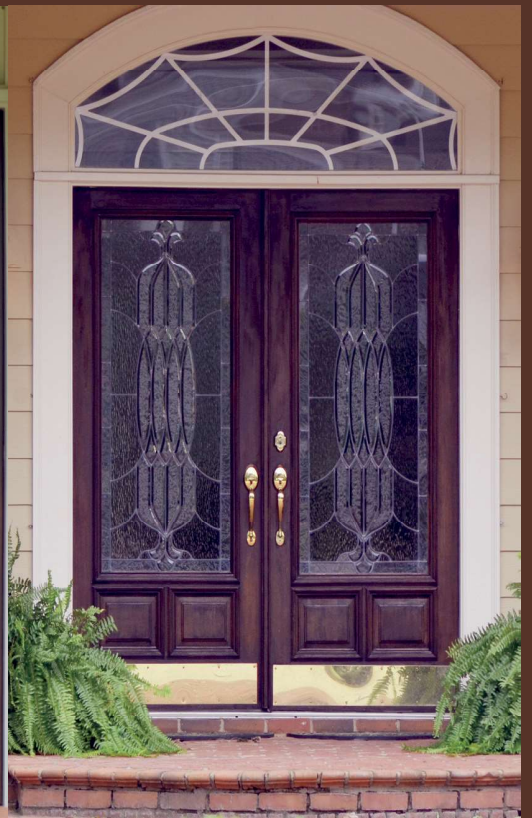



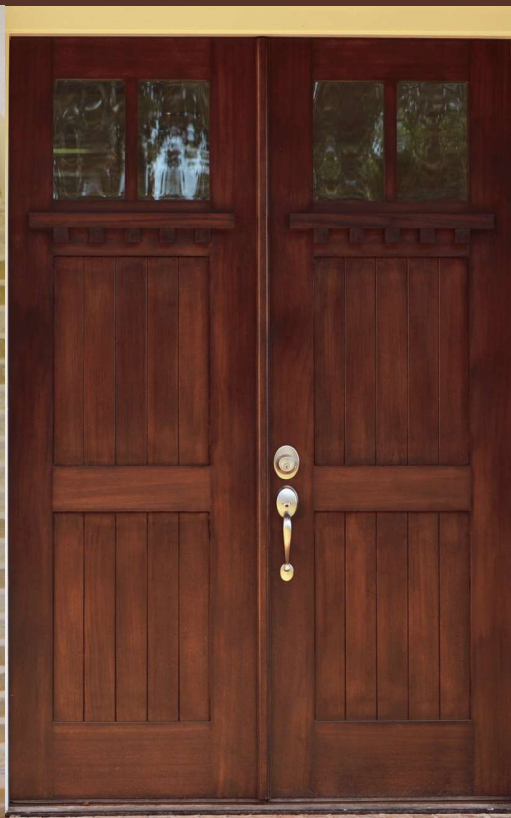

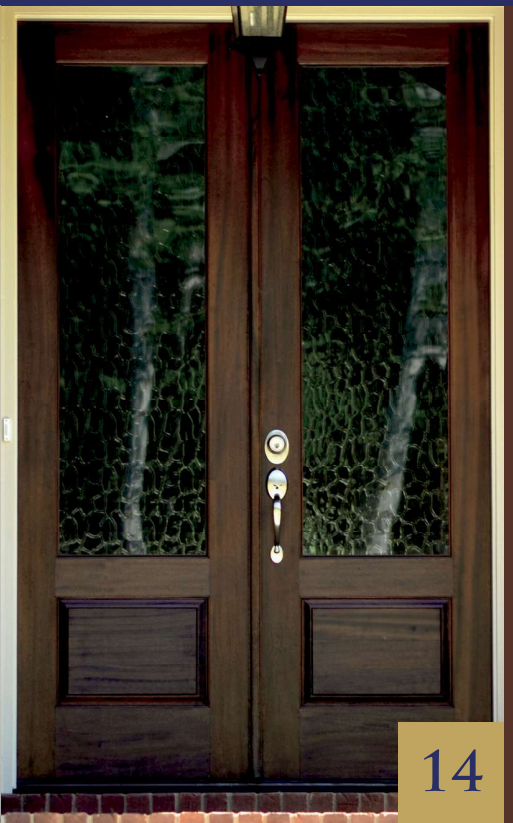







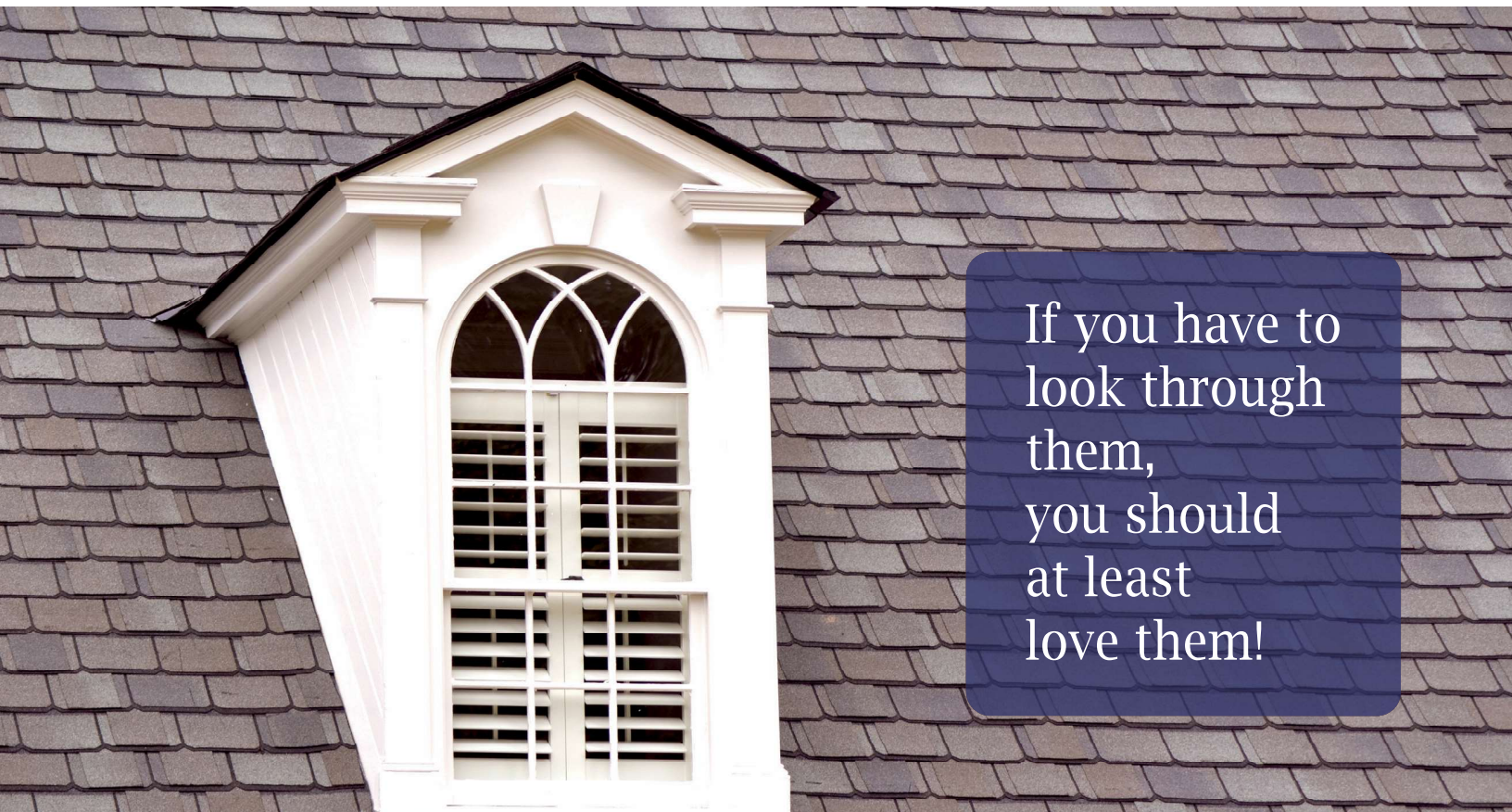

If you have to look through them, you should at least love them!

Custom Windows Previously Designed









Historical Renovations

Restoring the Quality of the Past

Across America the demand for effective historic restoration continues to grow as designers, facility owners, community planners realize the merit of preserving our country's architectural heritage.

At Dallas Millwork Inc. we offer a singular blend of specialized talents designed to deliver accurate restoration services: patience, craftsmanship, and careful attention to detail.

“Dallas Millwork:
where old world design
meets modern technology.”

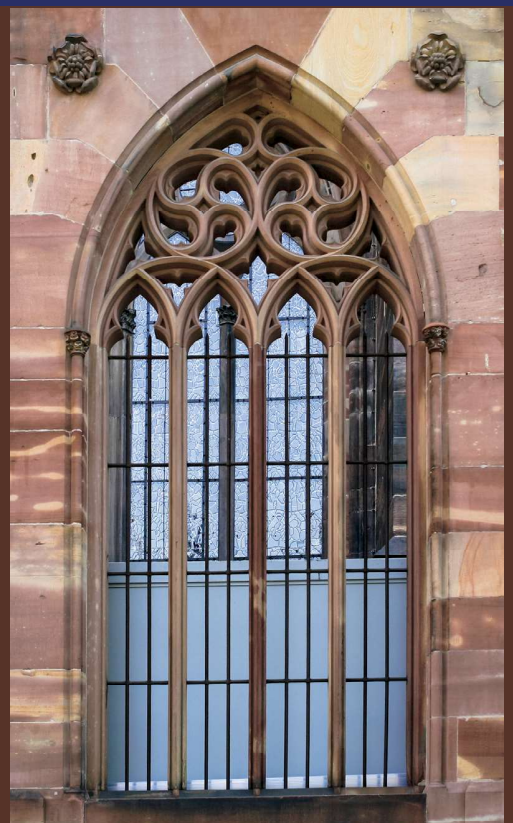

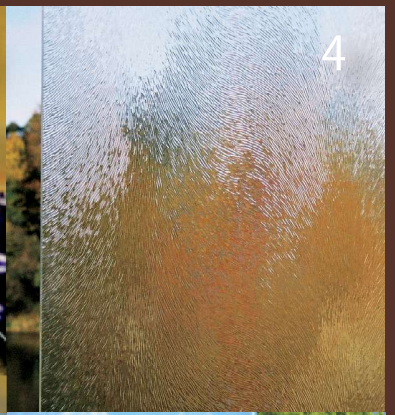
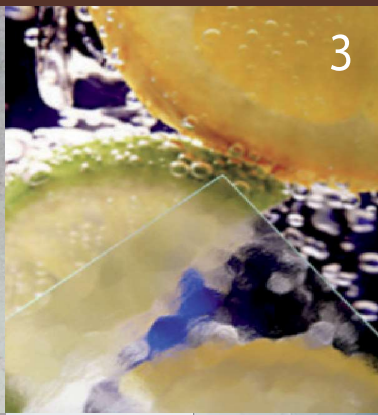
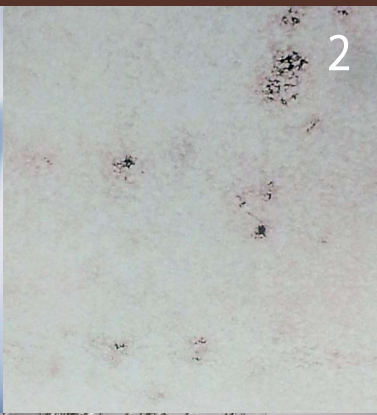

Glass Options

- 1. Acid Etch
- 2. Antique Mirror
- 3. Aquatex
- 4. Chichilla

- 5. Cotswald
- 6. Delta Frost
- 7. German Antique
- 8. Glacier

- 9. Krystal Pebbles
- 10. Monumental
- 11. Pattern 62
- 12. Rain

- 13. Reeded
- 14. Seedy
- 15. Taffeta
- 16. Winter Creek

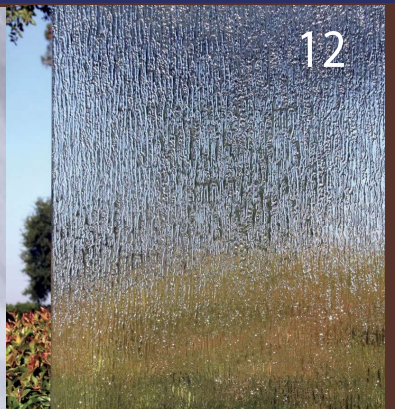
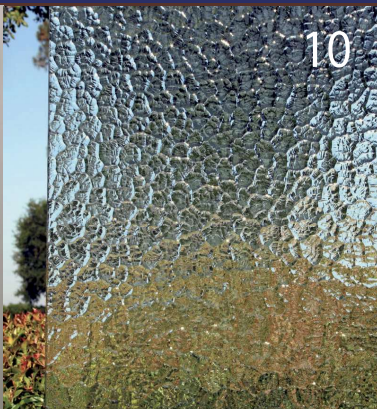



DALLAS
Millwork

EST. 1996

www.dallasmillwork.com

T: 770-943-3909 • F: 770-943-3900

1-888-MILLWORK

119 Sunnyland Dr. • Hiram, Georgia 30141